

ENT workstations

ATMOS C 21

ATMOS C 31

Compact in functionality and design



ATMOS C 21 / C 31

The space-saving system with added value

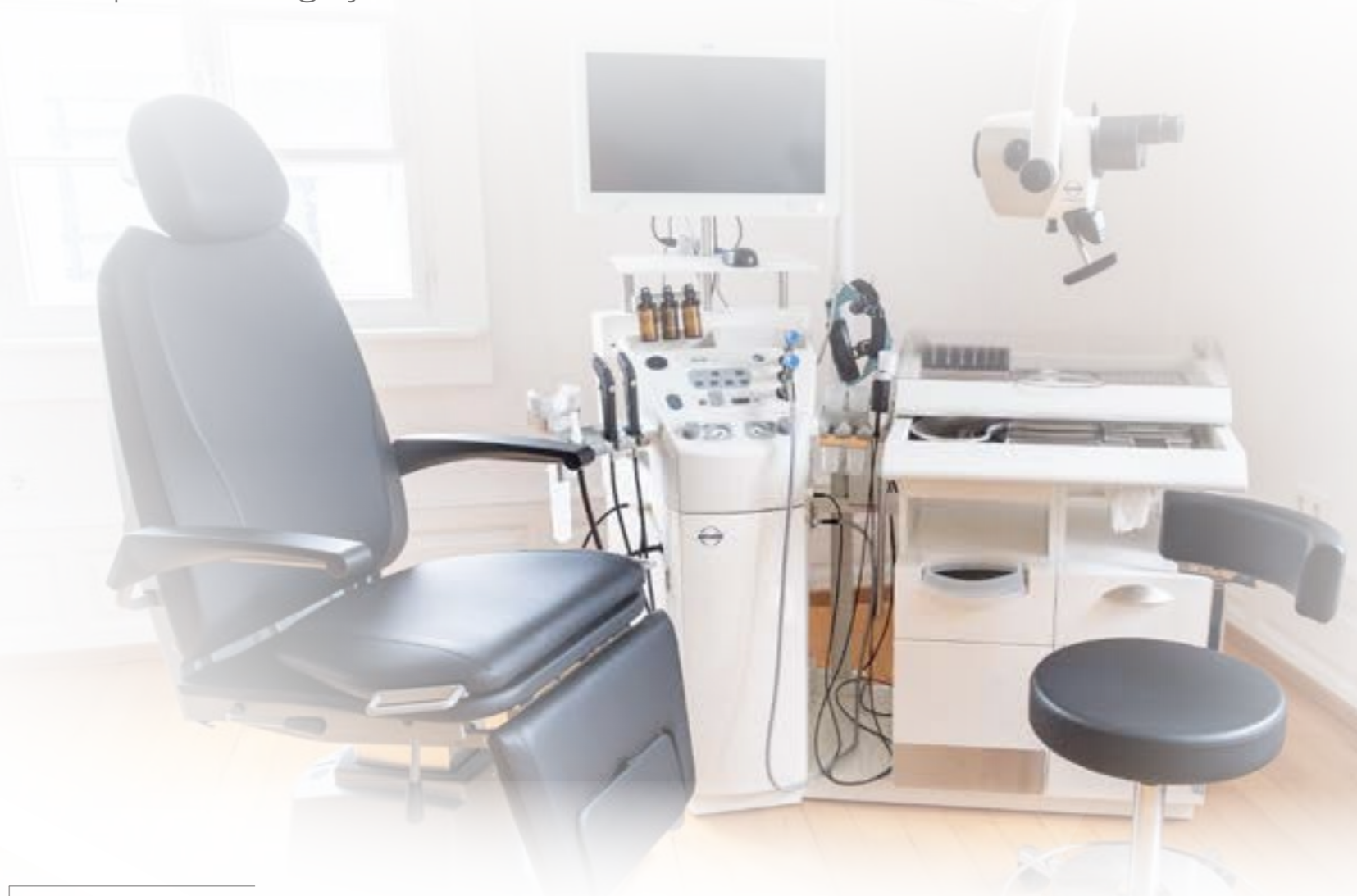

Better ambience

The attractive design of our treatment units helps you to make your patients feel comfortable during the treatment.

Less strain

The positioning of the individual control elements as well as the automatic starting and switching of the devices enables quick and straightforward use. This means you can work in a more relaxed and efficient manner.

Greater mobility

The treatment chair can be easily pushed aside to make room for moving patients in a hospital bed or wheelchair into the examination room.

More individual

Utilize your practice rooms to suit your individual needs by adapting single diagnostics modules from our treatment units.

More efficient

Only select the necessary modules and devices from our product range which you need for your work, thus keeping your expenses to a minimum.

Better hygiene

You can rely on the storage, disposal, disinfection and supply of instruments thanks to the elaborate hygiene and secretion management.

CONTENTS

TREATMENT UNITS

ATMOS C 21 / C 31 Page 4/5

COMPLETE SOLUTION

ATMOS 360° diagnostics Page 6/7

EQUIPMENT

Treatment chairs Page 8/9

Function column Page 10/11

Instrument management ATMOS C 21 / C 31 Page 12/13

MODULES

Lighting modules Page 14/15

Visualisation systems Page 16/17

Diagnostic equipment Page 18/19

THE CLASSIC CHOICE FOR STANDARD REQUIREMENTS

ATMOS C 21 / C 31

Functionality and efficiency
in perfect harmony

Innovative design and a favorable pricing are not mutually exclusive. The ATMOS C 21 / C 31 combines all the necessary functions required for an ENT workstation in one compact, economical device.

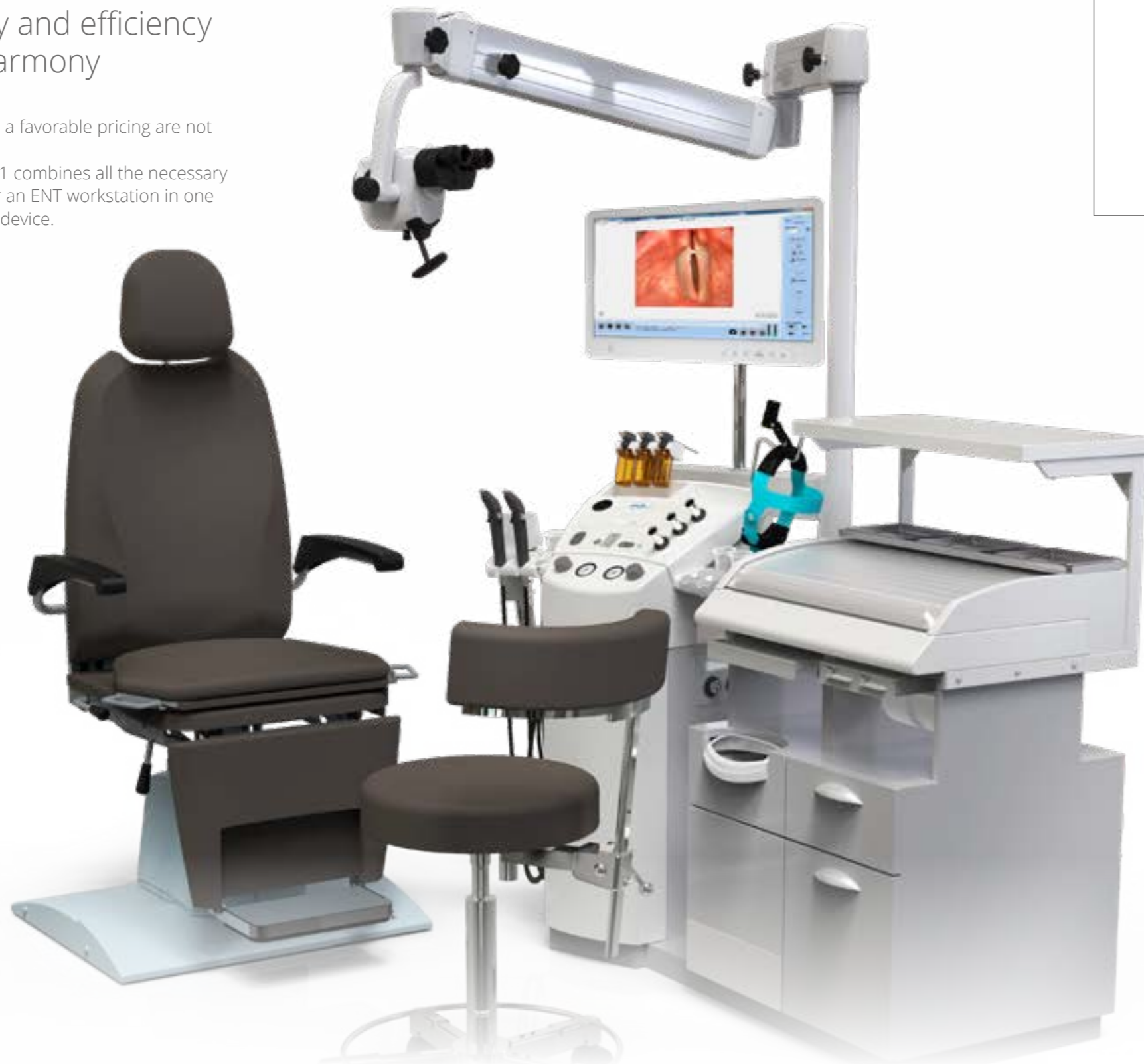

Function Column+ Microscope

Cabinet

Function Column

The heart of the unit and where all the important tools are kept:

- Suction unit
- Ear irrigation (only C 31)
- Compressed air / medication sprayer
- Economy lighting module
- Instrument management

Function Column + Cabinet

Extension for function column:

- Instrument deposit with cover
- Drawers
- Instrument disposal
- Waste bin
- Tongue patches / swab dispenser
- Pull-out desk

Function Column + Cabinet + Instrument cabinets

The comprehensive solution for instrument management:

- Instrument cabinet
- Instrument deposit with cover
- Instrument disposal
- Waste disposal
- Drawers
- Pull-out desk

THE ALL-ROUND SOLUTION FOR ENT CLINICS AND PRACTICES

ATMOS 360° diagnostics

Complete solution. Perfect workflow.

ATMOS 360° diagnostics is a comprehensive, modular, expandable range of network-compatible modules and devices that are easy to integrate into your existing clinic or practice structures. It guarantees comprehensive, reliable ENT diagnosis and enables you to optimise your workflow for greater efficiency.



Lower costs

The benefits for practice and clinic managers

The modular structure of our solution allows users to choose from a wide range of diagnostics modules and pick the exact ones they need for their work. The interface licensing costs are covered by a one-time fee that also applies to modules integrated into the system at a later date.



Simple HIS connection

The benefits for IT and system administration

Once installation is complete, IT managers will be able to connect additional modules with a minimum of time and effort. On top of this, the ATMOS Bridge and its built-in HL7 and DICOM interfaces guarantee a secure exchange of data with the existing IT systems.

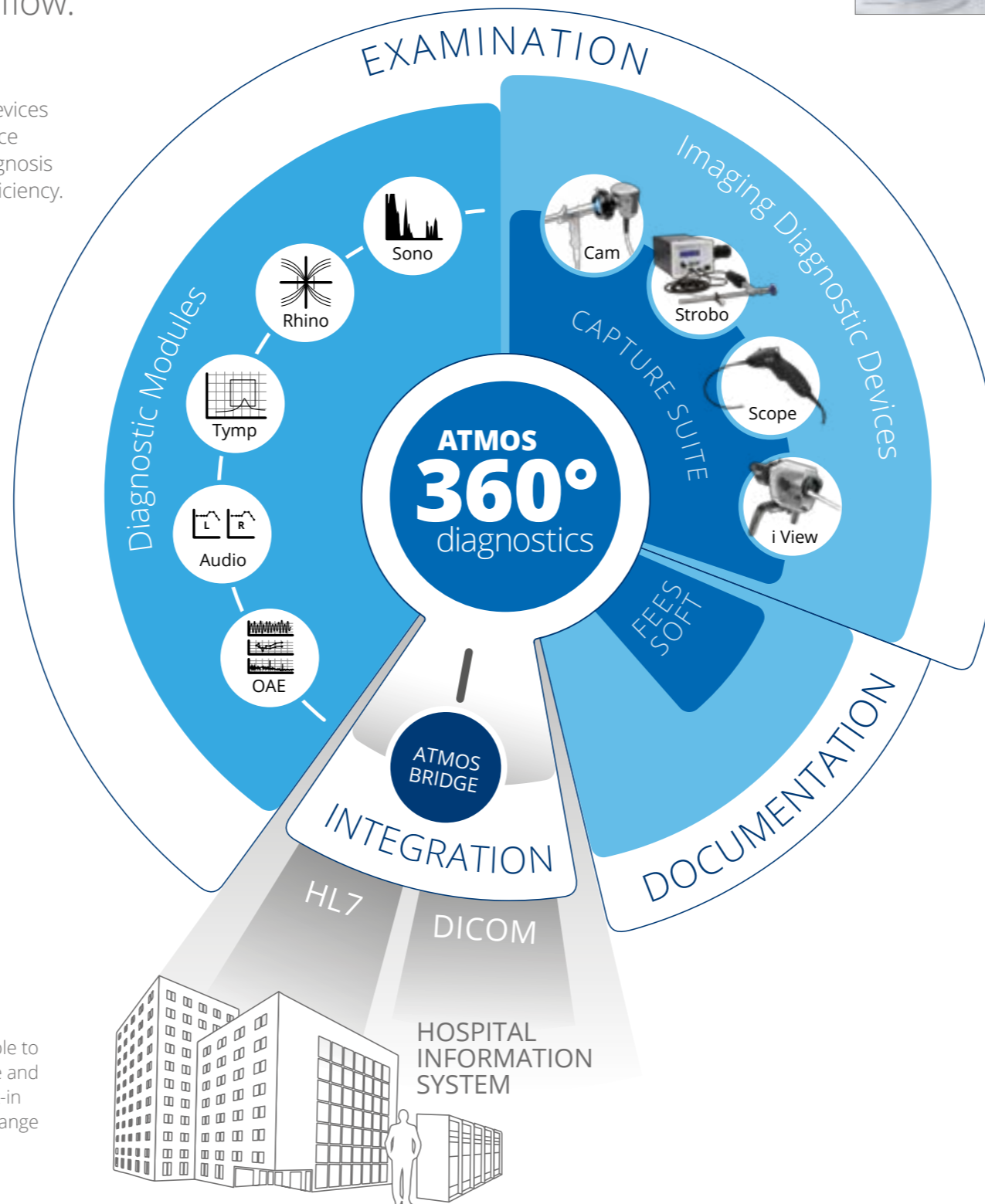

info



Find more detailed information on our network-capable all-in-one solution in our brochure

ATMOS 360° diagnostics



Reliable diagnosis

The benefits for doctors and specialists

ATMOS 360° diagnostics gives ENT medical specialists a comprehensive range of functions that will enable them to perform all the examinations required for ENT diagnosis. Its sophisticated product features and intelligent functions speed up control processes and ensure that the diagnosis is completed without errors.



Greater efficiency

The benefits for organisation and administration

ATMOS 360° diagnostics makes managing patient data and diagnosis results easier, makes the data exchange with the HIS or practice software more secure, and allows better preparation of data for further processing. This makes processes much faster, noticeably optimising the workflow.

PATIENT CHAIRS, DOCTOR'S CHAIRS

Treatment chairs

Combining design, technology and comfort

Your patient chair is the key element in your ENT treatment room. Make sure your patients feel safe and comfortable – with an ATMOS Chair. Our chairs set new standards with their soft and extremely hard-wearing surface, while the matching doctor's chair fulfils all the relevant safety requirements and can be adjusted easily to optimise doctor-patient positioning.



info

Find more information on our range of chairs in the brochure

ATMOS Chair

Versatile patient chairs

Built-in rollers for unbeatable mobility

- Entire chair can be moved with very little effort for flexible positioning – or even pushed out of the treatment room, if necessary

Adjustable backrest provides easy access to the patient

- Infinitely variable between approx. 7° forward tilt and 90° shock position
- Arm rests can be folded individually, and move synchronously with the backrest

Optimum positioning in just a few seconds

- Top section of chair can be rotated 360° and fixed in any position with the stop levers attached on both sides
- Electric height adjustment (max. lifting capacity 200 kg)
- Headrest with individual height adjustment
- Separate seating surface rotation (optional)



ATMOS Chair	Comfort Basic	Comfort Sync	Professional Basic	Professional Electrical	Professional Mobile	Professional Complete
Seat access height	56 cm		58 cm			
Seat height adjustable	Manual		Electric			
Seating surface rotates	-		Optional			
Lifting height	20 cm		30 cm			
Max. lifting capacity	150 kg		200 kg			
Backrest adjustable	Manual		Manual	Electric	Manual	Electric
Foot support	Fixed	Synchronous with backrest	Synchronous with backrest			
Mobility function	-		-		✓	

Premium upholstery material

Soft artificial leather for maximum seating comfort

- Soft feel
- Easy to clean
- Extremely durable and hard-wearing (up to three times more than conventional materials)

ATMOS Chair Premium colours

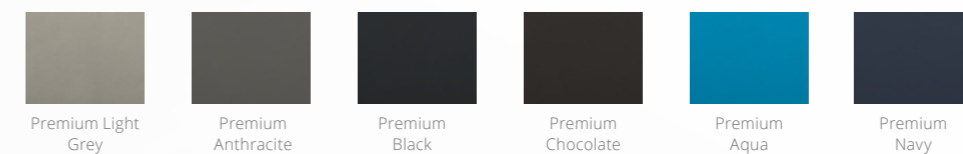

ATMOS Chair Compact colours

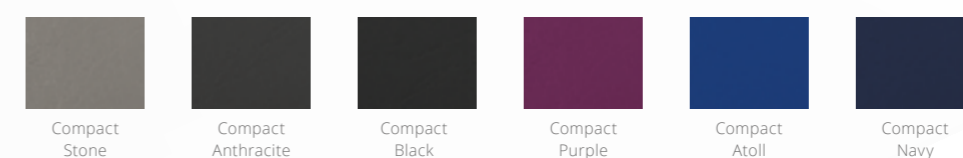

Ergonomic doctor's chairs

Optimum conditions for an ergonomic work posture that reduces back strain

- Adjustable backrest height
- Available with hand or foot adjustment mechanism
- Helps you to maintain an upright sitting posture

RINSING, SUCTION, SPRAYING

ENT Workstation

Versatility in tight spaces

Cut your walking distances and enjoy a more convenient way of working: the ATMOS C 21 / C 31 workstations combines all the important treatment modules in compact space. They are all durable, low-maintenance and quiet, making your work easy and enjoyable. One of the highlights of our treatment unit: all the functions start up automatically when you pick up the handles.



Medication sprayer

- Patented one-handed operation system prevents cross-contamination and makes sprayer changes easy
- Straight sprayer
 - Sprayer with extendible nozzle
 - Powder sprayer



Automatic activation

- All the functions of the ENT Workstation start up automatically when you pick up the corresponding handles, and can be controlled using one hand
- All the important treatment modules combined in a compact space



Hose rinsing unit

- Easy-access rinsing canister prevents blockages in the suction system
- With optional filling system for uninterrupted work



Ear irrigation system C21

- All parts which come into contact with water can be autoclaved, making them very easy to prepare
- With compressed air (500 ml per rinse)



Ear irrigation system C 31

- Uninterrupted ear irrigation with 5 liter storage canister



Suction systems

- Choose from two power classes
- Basic (40 l/min.)
 - Professional (55 l/min.), extremely quiet



Secretion canister system

- Automatic secretion canister drainage to allow uninterrupted work
- Direct docking system makes changing simple and prevents mistakes
 - Secretion canister system accessible from the front in the service chamber



Disposable systems

- Compatible with disposable secretion hoses and canisters provided by other manufacturers
- Serres®
 - Medi-Vac®
 - Receptal®

DRAWER AND DISPOSAL SYSTEMS, INSTRUMENT HEATING

Instrument management ATMOS C 21 / C 31

Greater organisational freedom

Optimise your workflow while maintaining compliance with hygiene requirements, even when you have a high patient turnover – with the sophisticated instrument management system included in our treatment units. The ATMOS C 21 / C 31 allows you to adapt the cabinets to suit your individual work habits.



Covers for instrument shelves

- Effective protection from dirt and contamination:
- Transparent cover
 - Roller cover (allows you to place additional shelves above the instrument level)



Instrument trays

Systematic instrument tray configuration using stainless steel, aluminium or melamine trays:

- Small and large trays
- Trays for ear speculums
- Tray for preheating mirrors
- Toothed trays to protect against cross-contamination

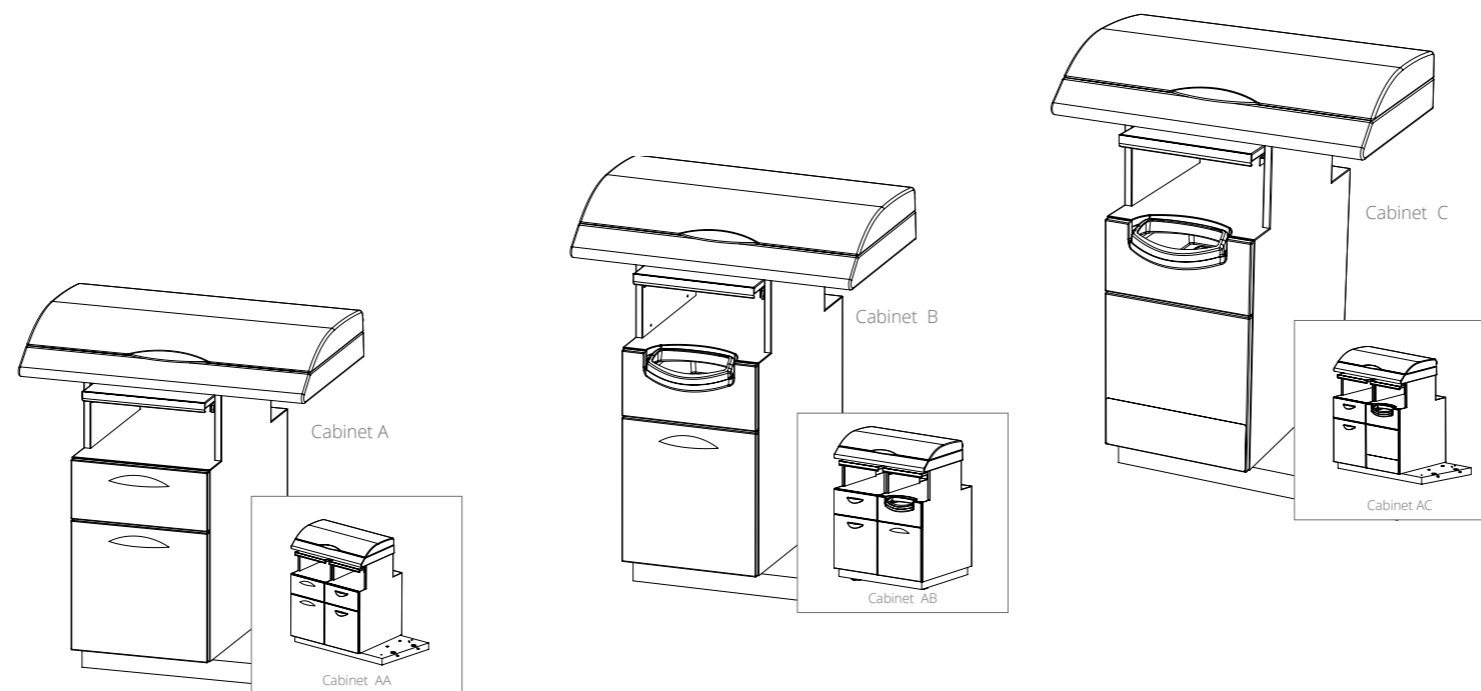

Instrument deposit 2nd level

- Twice the amount of space for your instruments:
- Upper deposit: Slidable to the rear
 - Lower deposit: Slidable to the front
 - Roller cover

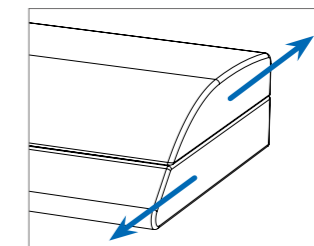

ATMOS C 21 / C 31	Cabinet A	Cabinet B	Cabinet C	Cabinet D
Instrument deposit with cover	■	■	■	■
Extractable writing surface, lockable	■	■	■	■
Open storage compartment	■	■	■	■
Upper drawer standard	■	-	-	-
Lower drawer high	■	■	-	-
Drawer for instrument deposit	-	■	■	-
Drawer for waste disposal	-	-	■	-
3 Standard drawers	-	-	-	■

All cabinets (A, B, C) can be combined with the extension cabinet A to become a double-unit.



Quick mirror heater

Pre-heat mirrors to body temperature to stop them from fogging up

LIGHT SOURCES, HEADLAMPS

Lighting modules

The latest technology for maximum performance

Our light sources offer a whole range of benefits for both you and your patients. For example, our LED lighting modules are passively cooled by a sophisticated ventilation system, are completely noiseless and do not stir up any dust. Thanks to the optimised light connection system, the endoscope and tissue never heat up, even when the unit is running at high power.



LED headlamps

The ATMOS HL 21 LED is light, zero-maintenance and produces the optimum colour temperature (daylight).

Additional options:

- Automatic activation
- Brightness control
- Cordless battery-powered unit



Conventional headlamps with fibre-optic cabling are also available as an alternative.



Endoscope light sources

Light handle ATMOS LS 21 LED fixed directly to the endoscope; no fibre optics required.

Additional options:

- Colour temperature: white
- Colour temperature: warm white
- Automatic activation
- Brightness control
- Can be battery-powered for extended mobility



Powerful ATMOS LED Light Cube light source with automatic activation and brightness control for all conventional fibre-optic systems:

- ATMOS
- Storz
- Olympus
- ACM
- Wolf

STROBOSCOPES, CAMERAS, MICROSCOPES, ENDOSCOPES

Visualisation systems

Top-class imaging diagnostics

Endoscopy and visualisation make ENT diagnostics more efficient and help patients to understand their diagnoses. You too can benefit from our imaging diagnostics solutions! Our devices come with a range of connection options for easy integration. Our ATMOS Capture Suite visualisation and archiving software allows for additional process optimisation.



ATMOS endoscopes

Full range of endoscopes for extensive visual diagnostics using optics and lighting

- Laryngoscopes
- Ear, nose and throat endoscopy
- Flexible nasopharyngoscope



ATMOS i View microscope

Our own comprehensive, harmonised system with optics and lighting

- Perfect for everyday tasks thanks to excellent handling
- Easy to integrate into the treatment unit



info

Find more information in our brochure

ATMOS i View



ATMOS stroboscopy module

Silent stroboscopy with LED technology

- Optimised for ATMOS laryngoscopes and cameras
- With built-in ATMOS light handle – no fibre-optics necessary



ATMOS ENT cameras

Available in standard resolution (ATMOS Cam 21/31) and HD resolution (ATMOS Cam 41 HD)

- Camera settings adapt automatically to changes in endoscope and microscope – no adjustments or white balancing necessary
- Built-in image memory allows you to save up to eight separate images (four simultaneously) for side-by-side comparison



ATMOS Scope digital nasal-pharyngo-laryngoscope

With ergonomic handle and ATMOS “chip on the tip” technology for extremely high-quality wide-angle images

- Light source, camera and microphone built into handle
- Outstanding depth of sharpness and clear, high-contrast imaging results
- Controlled using function buttons on the handle

SONOGRAPHY, TYMPANOMETRY, RHINOMANOMETRY

Diagnostic equipment

Comprehensive solutions working side by side

Optimise your workflow for routine examinations and cut your patients' waiting times with our ENT diagnostics package. It contains all the diagnostic equipment you need for rhinomanometry, sonography, tympanometry, and caloric stimulation. This allows you to take measurements quickly directly from the treatment unit.



Rhinomanometry

Unique hygiene concept with built-in filter pad for protection against bacteria and viruses

- Replaceable filter sheets in probe body prevent contamination of the insides of the probe
- Measurement data displayed in real-time as a rhinogram (breathing graph)

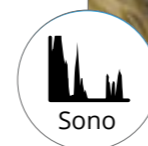

Sonography

Pre-set amplification parameters and depth scale for maxillary and frontal sinuses

- Foot switch and automatic mode for quick procedure and saving images
- Optional: manual operation using modifiable amplification curves for custom depth compensation

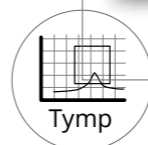

Tympanometry

Three real-time measurement procedures, each in its own interface

- Simple and intuitive operation
- Graphic and numerical results display

info



Find a detailed overview of all our diagnostic equipment in our brochure
ATMOS 360° diagnostics



MedizinTechnik

ATMOS MedizinTechnik GmbH & Co. KG
Ludwig-Kegel-Str. 16
79853 Lenzkirch / Germany
Tel: +49 7653 689-0
info@atmosmed.com

www.atmosmed.com