

OPERATING INSTRUCTIONS  
MEDAP  
CONNECTION TUBES

MEDAP 

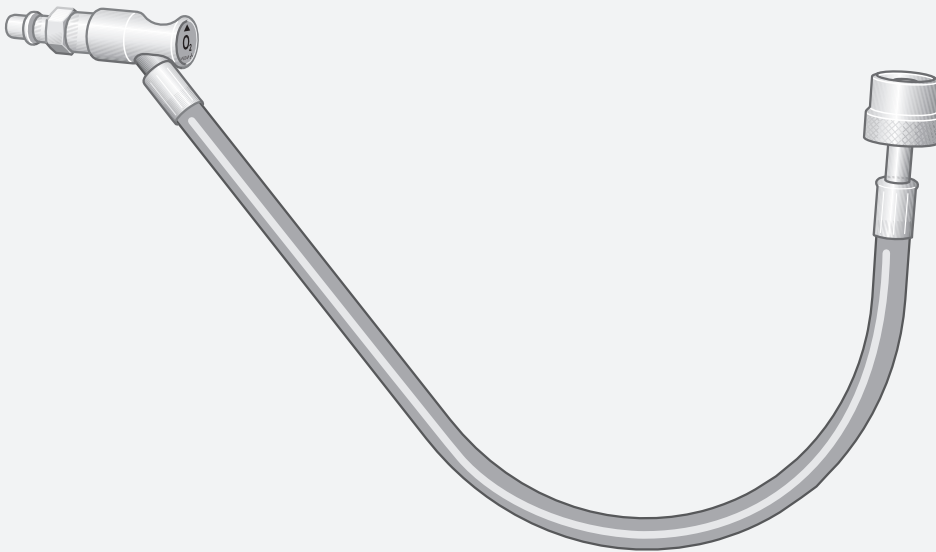

**Subject to technical modification!**

Illustrations and technical specifications may vary slightly from those in these Operating Instructions as a result of ongoing product development.

V10 2020-07





## Table of contents

|          |   |           |
|----------|---|-----------|
| <b>1</b> | <b>Introduction .....</b>                                     | <b>5</b>  |
| 1.1      | How to use these operating instructions .....                 | 5         |
| 1.1.1    | General .....   | 5         |
| 1.1.2    | Symbols .....   | 5         |
| 1.1.2.1  | Actions and responses .....                                   | 5         |
| 1.1.3    | Definitions .....   | 5         |
| 1.1.3.1  | Design of safety notes .....                                  | 5         |
| 1.1.3.2  | Structure of notes .....                                      | 6         |
| 1.2      | Disposal.....   | 6         |
| 1.2.1    | Packing .....   | 6         |
| 1.2.2    | ATMOS products.....   | 6         |
| 1.3      | Symbols used.....   | 6         |
| 1.4      | Basic requirements.....                                       | 7         |
| 1.4.1    | Use in accordance with the intended purpose .....             | 7         |
| 1.4.2    | Applicable standards.....                                     | 7         |
| 1.4.3    | Intended purpose .....  | 7         |
| 1.4.4    | Versions .....  | 8         |
| 1.4.4.1  | Connection tubes with NIST screw connectors .....             | 9         |
| <b>2</b> | <b>Safety notes .....</b>                                     | <b>10</b> |
| 2.1      | General.....  | 10        |
| <b>3</b> | <b>Initial operation, operation and use.....</b>              | <b>12</b> |
| 3.1      | Equipment inspection .....                                    | 12        |
| 3.2      | Connection tube with gas probe and NIST screw connector ..... | 12        |
| <b>4</b> | <b>Cleaning and disinfection.....</b>                         | <b>13</b> |
| 4.1      | Basic instructions .....                                      | 13        |
| 4.2      | Cleaning .....  | 14        |
| 4.2.1    | General .....   | 14        |
| 4.2.2    | Cleaning procedure.....                                       | 14        |
| 4.3      | Disinfection.....   | 15        |
| 4.3.1    | General .....   | 15        |
| 4.3.2    | Suitable disinfectants .....                                  | 15        |
| 4.3.3    | Disinfection procedure .....                                  | 15        |
| <b>5</b> | <b>Maintenance.....</b>                                       | <b>16</b> |
| 5.1      | General.....  | 16        |
| 5.2      | Period tests .....  | 16        |
| 5.3      | Malfunctions and troubleshooting.....                         | 16        |
| 5.4      | Repairs .....   | 17        |
| 5.5      | Service hotline:.....   | 17        |



|          |                                      |           |
|----------|--------------------------------------|-----------|
| 5.6      | Sending in the device.....           | 17        |
| <b>6</b> | <b>Technical specifications.....</b> | <b>18</b> |
| 6.1      | General.....                         | 18        |
| 6.2      | Ambient conditions.....              | 18        |

# 1 Introduction

## 1.1 How to use these operating instructions

### 1.1.1 General

These operating instructions are provided to familiarise you with the features of this ATMOS product. They are subdivided into several chapters.

**Please note:**

- Please read these operating instructions carefully and completely before using the product for the first time.
- Always proceed in accordance with the information contained herein.
- Store these operating instructions in a location near the product.

### 1.1.2 Symbols

#### 1.1.2.1 Actions and responses



The „☒“ symbol identifies an action taken by the user while the „✓“ symbol identifies the reaction that this will induce in the system.

**Example:**

- ☒ Turn on the light switch.
  - ✓ Lamp lights up.

### 1.1.3 Definitions

#### 1.1.3.1 Design of safety notes

| Pictogram   | Descriptor   | Text   |
|---|--|--|
|  | <b>DANGER!</b><br>Indicates a direct and immediate risk to persons, which may be fatal or result in most serious injury.         | The text for the safety note describes the type of risk and how to avert it. |
|  | <b>WARNING!</b><br>Indicates a potential risk to persons or property which may result in health hazard or grave property damage. |  |
|  | <b>CAUTION!</b><br>Indicates a potential risk to property which may result in property damage.                                   |  |

Tab. 1: Design of safety notes

**1.1.3.2 Structure of notes**

| Pictogram | Descriptor  | Text  |
|-----------|-------------|---|
|           | <b>NOTE</b> | Supplementary assistance or further useful information without potential injury to persons or property damage is described in the text of the note. |

Tab. 2: Structure of notes

**1.2 Disposal**

|  |  |
|--|--|
|  | <p><b>WARNING!</b><br/>Infection hazard!<br/>The product or some of its components may be contaminated after use.<br/>Clean and disinfect the product before disposal.</p> |
|--|--|

**1.2.1 Packing**





The packing is made of materials compatible with the environment. ATMOS will dispose of the packing materials upon request.

**1.2.2 ATMOS products**

ATMOS will take back used products or those which are no longer in service.  
Please contact your ATMOS representative for more detailed information.

**1.3 Symbols used**

| Symbols | Identification   |
|---------|--|
|         | Labelling for products which were developed and are marketed in compliance with the 93/42/EEC Medical Products Directive. Class Is, Im, IIa, IIb and III products are also marked with the identifying number for the notified body. |
|         | Labelling in compliance with the ISO 15223-1 standard.<br>Symbol for "Name and address of the manufacturer as well as date of manufacture".  |
|         | Labelling in compliance with the ISO 15223-1 standard.<br>Symbol for "Date of manufacture".  |
|         | Labelling in compliance with the ISO 15223-1 standard.<br>Symbol for "Follow Operating Instructions".  |
|         | Packaging label.<br>Symbol for "Keep dry".   |

| Symbols   | Identification  |
|---|---|
|  | Labelling in compliance with the ISO 15223-1 standard.<br>Symbol for "Temperature limitations". |
|  | Labelling in compliance with the ISO 15223-1 standard.<br>Symbol for "Relative humidity".       |
|  | Labelling in compliance with the ISO 15223-1 standard.<br>Symbol for "Atmospheric pressure".    |
|  | Labelling in compliance with the ISO 15223-1 standard.<br>Symbol for "Product number".          |
|  | Labelling in compliance with the ISO 15223-1 standard.<br>Symbol for „Batch number“.            |

Tab. 3: Symbols

## 1.4 Basic requirements

### 1.4.1 Use in accordance with the intended purpose

#### Product

As per appendix IX of the Medical Products Directive 93/42/EU this product belongs to class IIa. In accordance with this directive the product may only be used by persons who have been instructed how to use this product by an authorised person. This product is to be used exclusively for human medicine. When employed in a commercial or business use, this product shall be entered in the inventory.

#### Accessories

Accessories or combinations of accessories may be utilised only as and when indicated in these operating instructions. Other accessories, combinations of accessories and consumable items may be used only if they have a valid certification, are intended expressly for the particular use and will not adversely affect performance, the prescribed ambient conditions or safety requirements.

### 1.4.2 Applicable standards

The product satisfies the basic requirements set forth in Annex I to the 93/42/EU Directive drafted by the Medical Products Council (Medical Products Directive) as well as the applicable national (German) codes and the Medical Products Act in Germany. This has also been demonstrated through the application of the corresponding standards, which have been harmonised with the 93/42/EEC Directive.

### 1.4.3 Intended purpose

Name: Connection tubes with gas probe and NIST screw connection

|                                     |  |
|-------------------------------------|--|
| Main function:                      | Supply of compressed medical gases or vacuum to a device or a controller for medical gases or vacuum   |
| Medical indications / application:  | Connection between a terminal unit for compressed medical gases or vacuum with a controller (e.g. vacuum controller) or a device (e.g. anaesthetic machine)  |
| Specification of the main function: | The connection tube has a media-coded gas probe at one end and a media-coded NIST screw connection at the other end. The compressed medical gases or vacuum are extracted from a gas-type-specific terminal unit of a central gas supply system by the gas probe of the connection tube being inserted into the terminal unit. The NIST screw connection of the connection tube is connected to a device suitable for the combination. The permitted supply pressure is between 400 kPa and 500 kPa +/-10 % for compressed gases and -100 kPa to -60 kPa for a vacuum.   |
| User profile:                       | Doctor, medically trained staff  |
| Patient groups:                     | Patients of all ages   |
| Application organ:                  | No specific organ  |
| Application time:                   | For continuous operation; in practice short-term use on the patient (< 30 days)  |
| Application site:                   | The application site is the clinical environment and doctor's practices which do have a central gas supply system. The application of the product may only be performed by medically trained and introduced staff.   |
| Contraindications:                  | The connection tubes with gas probe and NIST screw connection may not be used for the following purposes: <ul style="list-style-type: none"> <li>• Outside the medical sector</li> <li>• In MR areas</li> <li>• For ultra-pure gases</li> <li>• For liquids</li> <li>• For corrosive, aggressive and toxic gases, acetylene, propane, butane and other flammable gases</li> <li>• With central gas supply systems with other supply pressures than 400 kPa to 500 kPa +/- 10 % for compressed gases and -100 kPa to -60 kPa for vacuum</li> <li>• The undosed supply of medical gases (connection of tapping units intended for this purpose is strictly necessary)</li> </ul> |
| The product is:                     | Not active   |
| Sterility:                          | No sterile product   |
| Single-use product / reprocessing:  | The product and parts of the accessories are reusable. For information on reprocessing, cleaning and disinfection please see the operating instructions.   |

**1.4.4 Versions**

Products and accessories are only permitted with the ISO colour coding. In Germany, Austria and Switzerland, products with neutral colour coding are also permitted.



**NOTE**

Gas probes of DIN, BS, NFS and SS connection tubes can be rotated, gas probes of MEDAP and UNI connection tubes cannot be rotated.

---

**1.4.4.1 Connection tubes with NIST screw connectors**

- Connection tubes for compressed air
- Connection tubes vacuum
- Connection tube oxygen
- Connection tubes laughing gas

## 2 Safety notes

### 2.1 General

**DANGER!**

Fire/explosion hazard!

Air, oxygen and oxygen compounds react explosively with oils, greases and lubricants. Fire and explosion hazard due to compressed gases.

Keep the product, especially for oxygen and nitrous oxide, free of oils, greases, lubricants and hand creams. Only use lubricants which are approved by ATMOS. Observe fire protection regulations when dealing with combustion-enhancing gases. Contact Technical Service about any leakages in the product.

**DANGER!**

Fire hazard!

Fire hazard as a result of escaping oxygen.

Never smoke near equipment which carries oxygen and avoid using open fires or glowing objects. Check tight fitting and firm seat of the connector when mounting accessories.

**DANGER!**

Fire hazard!

The product may ignite if the maximum operating pressure or the maximum operating temperature is exceeded.

Do not exceed the maximum operating pressure or maximum operating temperature.

**DANGER!**

Defective product!

Using incorrect spare parts and accessories can cause injuries or equipment failure.

Only use original accessories or spare parts.

**WARNING!**

Risk of injury!

Worn or damaged products can cause injuries.

Use only products which are in perfect condition.

**CAUTION!**

Property damage!

Ensure that mechanical forces are not able to act on the connection tube, tube connection and gas probe as this may cause malfunctions or damages.

**WARNING!**

Malfunction!

Do not expose the product to torsion, as this might impair its proper function. Mount accessories in such a way that they remain torsion-free and tension-free.

**WARNING!**

Ambient conditions!

If the ambient temperature range specified for shipping, operation and/or storage conditions is not maintained, then no guarantee can be assumed for the accuracy, mechanical strength or tightness of the product.

**DANGER!**

Health hazard!

Pay attention that the product is connected to the appropriate gas type and that the screw connection is firmly seated.

**DANGER!**

Danger to life!

When using oxygen, a kink in the connection tube may cause the oxygen supply to be interrupted.

Ensure that there are no kinks in the connection tube.

**WARNING!**

Configuration of the overall system!

The configuration of the overall system as well as the functional testing are subject to the overall responsibility of the medical staff.

The operator must check proper functionality and suitability of the product for each intended application before every use, in particular connection parts, tightness and suitability concerning material, work pressure and flow rate.

**WARNING!**

Risk of injury!

Products which are improperly mounted can loosen and cause injuries.

Mount the product properly.

**CAUTION!**

Property damage!

Never use contaminated gas probes.

**CAUTION!**

Property damage!

The plug-in valve may be damaged if the wrong gas probe is connected.

**CAUTION!**

Reduced performance!

Length and inside diameter of the product used may impair the maximum available gas volume.

Check the gas volume available at the tapping unit.

### 3 Initial operation, operation and use



**NOTE**

Please consult the manufacturer's documents for the operation of the gas probe and connected equipment.

#### 3.1 Equipment inspection

- ☒ Before using the unit for the first time, perform a wipe disinfection.
- ☒ Examine the product for correct functioning and contamination or damages.

#### 3.2 Connection tube with gas probe and NIST screw connector

Mounting of the connection tube with gas probe and NIST screw connector is described using the FINA AIR B 800 gas probe unit.

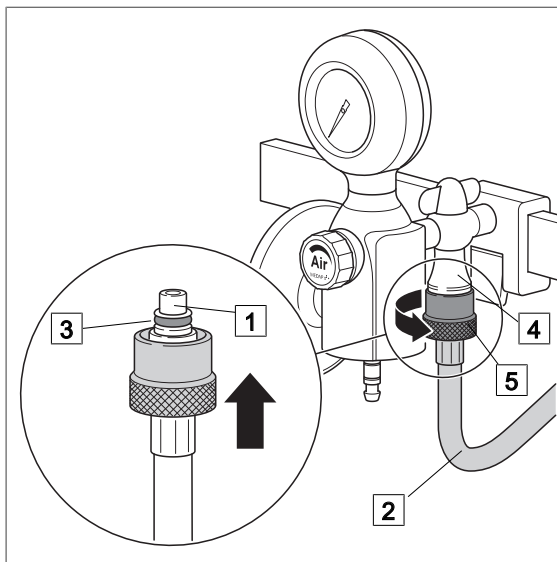

#### Mounting the connection tube

- ☒ Check whether the NIST nipple (1) of the connection tube (2) is fitted with a flat seal (3).
- ☒ Plug the NIST nipple of the connection tube into the NIST housing (4) of the tapping unit.
- ☒ Tighten the cap nut (5) by hand.
- ☒ Insert the gas probe of the connection tube into the terminal unit.

Fig. 1: Connection tube with NIST screw connector

## 4 Cleaning and disinfection

### 4.1 Basic instructions

The product must be cleaned as well as wipe disinfected after every use.

**DANGER!**

Risk due to incorrect use of detergents and disinfectants!

It is strictly advised to observe the manufacturer instructions regarding how to use the detergents and disinfectants as well as the valid hospital hygiene rules.

**DANGER!**

Infection hazard!

Product may be contaminated.

Always wear gloves for cleaning / disinfection.

**DANGER!**

Infection hazard!

Particles of grime may become encapsulated and lead to the product not reaching the desired germ-reduction after disinfection.

Before disinfection, the product must be cleaned thoroughly of contamination and encapsulated particles of grime.

**DANGER!**

Health hazard!

The product is also used to administer respiratory gas. Residues of sterilisation gases or other substances in the unit could endanger the patient's health.

Do not disassemble the product and do not clean it by gas sterilisation or any other mechanical cleaning or sterilisation method. Ensure that no disinfectant or cleaning agent enters the product.

**CAUTION!**

Improper cleaning and disinfection can cause property damage!

Do **not** use the following products for cleaning and disinfection:

- Products containing alcohol (e. g. hand disinfectants)
- Halogenides (e. g. fluorites, chlorides, bromides, iodides)
- Dehalogenating compounds (e. g. fluorine, chlorine, bromine, iodine)
- Products that may scratch the surface (e. g. scouring agents, wire brushes, wire wool)
- Standard commercial solvents (e. g. benzene, thinner)
- Water containing iron particles
- Cleaning sponges containing iron
- Products containing hydrochloric acid

Use a soft, lint free cloth or a soft nylon brush to clean the product.

**CAUTION!**

Improper cleaning and disinfection can cause property damage!

Use only as much detergent and disinfectant as required.

**CAUTION!**

Improper cleaning and disinfection can cause property damage!

Perform visual and functional inspections after each cleaning and disinfection process.

**CAUTION!**

Property damage!

The product is not suitable for live steam sterilisation or spray disinfection!

Do not clean the product by live steam sterilisation or spray disinfection.

**CAUTION!**

Property damage!

Using non-colour-fast drapes can cause discolouration of surfaces.

Only use colour-fast drapes.

**4.2 Cleaning****4.2.1 General****CAUTION!**

Improper cleaning can cause property damage!

Residues of physiological saline solutions (e. g. sodium chloride) can attack the surfaces of the product.

Remove residues of physiological saline solutions with a cloth dipped in clean water. Then dry the product with a dry, lint free cloth.

**CAUTION!**

Improper cleaning can cause property damage!

Do not spray cleaning agent directly into the joints or gaps and never use a high-pressure cleaning unit!

**NOTE**

Use only all-purpose cleaners which are slightly alkaline (soap solution) and contain tensides and phosphates as the active cleaning agents.

In the event of heavily contaminated surfaces, use concentrated multi-purpose detergent.

**4.2.2 Cleaning procedure**

- Use the correct dose of multi-purpose detergent with water for the degree of surface contamination and in accordance with the instructions of the detergent manufacturer.
- Thoroughly wipe off the product with a soft cloth slightly wetted in a multi-purpose detergent solution.
- Ensure that the product is free of contamination and encapsulated particles of grime.
- Thoroughly wipe off the product with a soft cloth dipped in clean water.
- Ensure that the product is free of detergent residues.
- Dry product with a dry, absorbent and lint free cloth.
  - ✓ This will help to reduce pathogen growth on the product's surface.
- Wipe disinfect the product after every cleaning process.

**4.3 Disinfection**

**4.3.1 General**



**NOTE**

In the event of product surfaces that are very dirty, carry out an additional cleaning procedure before disinfecting the product.



**CAUTION!**

Material damage due to excessive exposure times!

Exceeding the specified exposure time of the disinfectant may damage the surfaces.

Observe the specified exposure time of the disinfectant manufacturer.

**4.3.2 Suitable disinfectants**

Only surface disinfectants based on the following combinations of active ingredients may be used for disinfection:

- Aldehydes
- Quarternary ammonium compounds
- Guanidine derivatives

| Ingredient group               | Active ingredients   |
|--------------------------------|--|
| Aldehydes                      | 2-ethyl-1-hexanal, formaldehyde, glutardialdehyde, glyoxal, o-phthaldialdehyde, succinaldehyde   |
| Quarternary ammonium compounds | Alkyl-didecyl-polyoxethyl ammonium propionate, alkyl-dimethyl-alkylbenzyl ammonium chloride, alkyl-dimethyl-ethyl ammonium chloride, alkyl-dimethyl-ethylbenzyl ammonium chloride, benzalkonium propionate, benzalkonium chloride (alkyl-dimethyl-benzyl ammonium chloride, coco-dimethyl-benzyl ammonium chloride, lauryl-dimethylbenzyl ammonium chloride, myristyl-dimethyl-benzyl ammonium chloride), benzethonium chloride, benzyl-dihydroxyethyl-coco-alkyl ammonium chloride, dialkyl-dimethyl ammonium chloride (didecyldimethyl ammonium chloride), didecyl-methyl-oxyethyl ammonium propionate, mecetronium-ethyl sulfate, methyl-benzethonium chloride, n-octyl-dimethyl-benzyl ammonium chloride |
| Guanidine derivatives          | Alkyl-biguanide, chlorhexidine-digluconate, cocospropylene-diamine guanidinium diacetate, oligomeric biguanide, polyhexamethylene biguanide hydrochloride (oligo-diimino imido-carbonyl imino-hexamethylene, polyhexanide)   |

Tab. 4: Active ingredients of disinfectants

**4.3.3 Disinfection procedure**

- Wipe disinfect the product in accordance with the instructions of the disinfectant manufacturer after every cleaning process.
- Ensure that the product is free of disinfectant residue.
- Perform visual and functional inspections.

## 5 Maintenance

### 5.1 General

Maintenance, repairs and period tests may only be carried out by persons who have the appropriate technical knowledge and are familiar with the product. To carry out these measures the person must have the necessary test devices and original spare parts.

ATMOS recommends: Work should be carried out by an authorized ATMOS service partner. This ensures that repairs and testing are carried out professionally, original spare parts are used and warranty claims remain unaffected.

### 5.2 Period tests

At least every 5 years a test must be performed.

### 5.3 Malfunctions and troubleshooting

| Defect  | Source of malfunction  | Corrective actions   |
|---|--|--|
| No or reduced capacity on tapping unit or anaesthetic machine                       | Tube is leaking  | <input checked="" type="checkbox"/> Check connection tube, if necessary, replace.  |
|   | System is leaking  | <input checked="" type="checkbox"/> Contact Technical Service.   |
|   | Failure of central supply system   |  |
| Gas escapes at the NIST screw connector   | Seal on the screw connector defective  | <input checked="" type="checkbox"/> Contact Technical Service.<br><input checked="" type="checkbox"/> Replace seal.                                |
|   | Screw connector not screwed tightly  | <input checked="" type="checkbox"/> Check screw connector and, if necessary, tighten.  |
| Gas escapes without connected gas probe   | Seal on the terminal unit defective  | <input checked="" type="checkbox"/> Contact Technical Service.<br><input checked="" type="checkbox"/> Continue supply using another terminal unit. |
| Gas escapes from the terminal units with connected gas probe of the connection tube |  | <input checked="" type="checkbox"/> Replace the seal on the plug-in valve, if necessary, replace the entire plug-in valve.                         |
| Gas probe of the connection tube cannot be inserted into the terminal unit          | Incorrectly selected connection tube and gas probe or deformation of gas probe | <input checked="" type="checkbox"/> Check connection tube and gas probe, if necessary, use correct connection tube.                                |
|   | Terminal unit has the wrong gas type   | <input checked="" type="checkbox"/> Use correct terminal unit.   |
| Gas probe cannot be locked  | Defective or contaminated terminal unit  | <input checked="" type="checkbox"/> Contact Technical Service, have terminal unit checked.   |
| Screw connector cannot be tightened   | Wrong screw connector has been selected  | <input checked="" type="checkbox"/> Check corresponding media for screw connector, if necessary, replace connection tube.                          |
|   | Thread is damaged  | <input checked="" type="checkbox"/> Contact Technical Service.   |

Tab. 5: Corrective actions



#### 5.4 Repairs

The following may require repairs from the manufacturer or an authorized service partner:

- Liquid has penetrated the device.
- The performance has significantly decreased.
- Inexplicable notifications appear.
- Abnormal noises occur.
- Functional faults cannot be rectified according to the measures in chapter Malfunctions and troubleshooting [▶▶ page 16].

If defects are detected the product may not be used any longer.

Make a note of the deficiencies and the REF number on the data plate and inform the responsible ATMOS Service.

Observe the information in chapter Sending in the device [▶▶ page 17].

#### 5.5 Service hotline:

+49 7653 689-0

#### 5.6 Sending in the device

- Remove and properly dispose of consumables.
- Clean and disinfect the product and accessories according to the operating instructions.
- Place used accessories with the product.
- Fill in the form QD 434 „Delivery complaint / return shipment“ and the respective **decontamination certificate**.

This form is enclosed with each delivery and can be found at [www.atmosmed.com](http://www.atmosmed.com).

- The device must be well padded and packed in suitable packaging.
- Place the form QD 434 „Delivery complaint / return shipment“ and the respective **decontamination certificate** in an envelope.
- Affix the envelope to the outside of the package.
- Send the product to ATMOS or to your dealer.

## 6 Technical specifications

### 6.1 General

|  |                         |
|--|-------------------------|
| Classification as per Medical Products Directive 93/42/EEC | Class IIa               |
| Nominal supply pressure for compressed gases               | 400 - 500 kPa $\pm$ 10% |
| Nominal supply pressure for vacuum                         | -100 kPa to -40 kPa     |

### 6.2 Ambient conditions

|  |                     |
|--|---------------------|
| Temperature: Shipping / storage          | -15 °C to +50 °C    |
| Temperature: Operation                   | -10 °C to +40 °C    |
| Relative humidity: Shipping / storage    | 10 % to 90 %        |
| Relative humidity: Operation             | 30 % to 75 %        |
| Atmospheric pressure: Shipping / storage | 700 hPa to 1060 hPa |
| Atmospheric pressure: Operation          | 700 hPa to 1060 hPa |

## Notes

MEDAP 

■ **Manufacturer:**

ATMOS  
MedizinTechnik GmbH & Co. KG  
Ludwig-Kegel-Str. 16  
79853 Lenzkirch  
GERMANY  
Phone: +49 7653 689-0  
[www.atmosmed.com](http://www.atmosmed.com)